

CONTACT : PRODEX@TORBEL.COM - 04 93 91 72 54

CHOISIR SES CACHE-FICHES ET CACHE-PAUMELLES EN 3 ÉTAPES.

1 CHOIX DU SUPPORT

Paumelle :

Fiche Bois :

Fiche PVC :

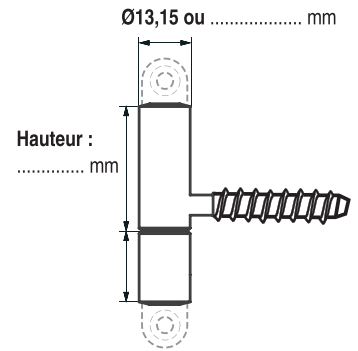
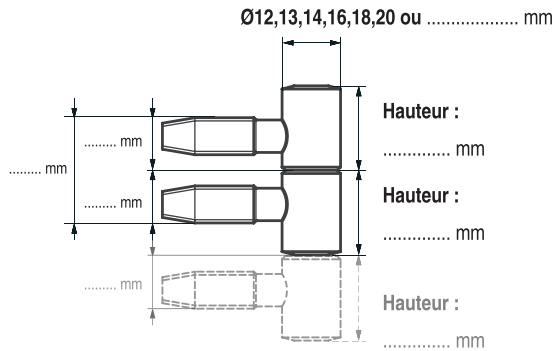
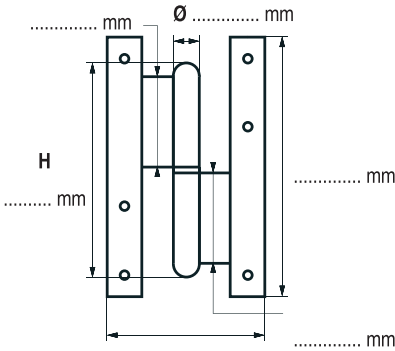

Bouts carrés

Bouts ronds

Epaisseur de lame : mm

Nombre de broches par demi-fiches :
Référence fiche :
Préciser le Ø de la fiche si > à 8 mm : mm

Modèle :

- «Type» P09 : Vis apparente
- «Type» P39 : Vis cachée

2 CHOIX DE LA FORME

Déco :



Classique :

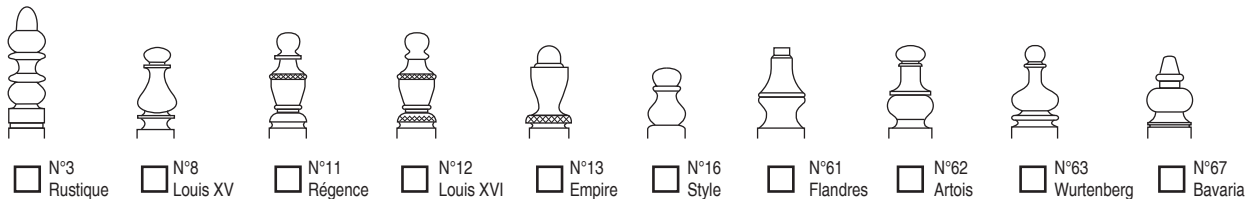

Modulable : (composée d'une tête et d'une bague)



3 CHOIX MATIÈRE ET FINITION

ÉPOXY - TOUTES MATIÈRES

Acier Laiton Inox Alu

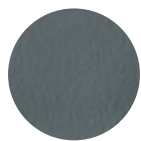

Epoxy noir 9005/10



Epoxy blanc 9010/80



Epoxy blanc 9016/80



Epoxy gris foncé



Epoxy rouille

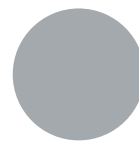

Epoxy gris agathe

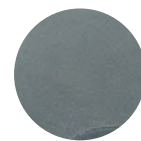

Gris authentique

ACIER

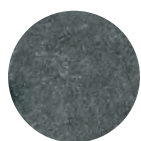

Acier patiné
verni

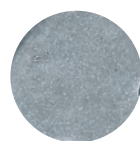

Acier cimenté
patiné verni



Acier cimenté
patiné argent verni



Acier laitonné
vieux bronze verni

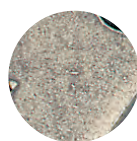

Acier laitonné
patiné verni



Acier dorure
verni

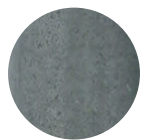

Acier poli

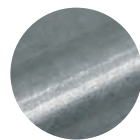

Acier poli
verni

LAITON

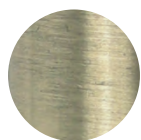

Laiton Vieux bronze
verni



Laiton chromé
brillant

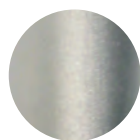

Laiton nickel
mat champagne

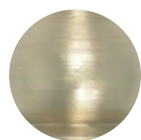

Laiton satiné
verni



Laiton patiné
verni



Laiton poli

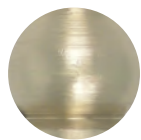

Laiton poli
verni

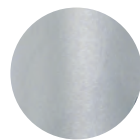

Laiton nickel
mat chromé



Laiton chromé
satiné aspect inox

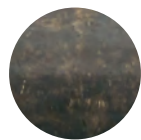

Bronze
médaille

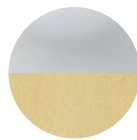

Epoxy blanc/
Laiton poli

INOX



Inox 304 brossé

ALUMINIUM

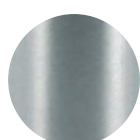

Aluminium brossé

QUANTITÉ :